

United States Department of the Interior National Park Service

National Register of Historic Places Registration Form

JAN 27 1989 NATIONAL REGISTER

This form is for use in nominating or requesting determinations of eligibility for individual properties or districts. See instructions in Guidelines for Completing National Register Forms (National Register Bulletin 16). Complete each item by marking "x" in the appropriate box or by entering the requested information. If an item does not apply to the property being documented, enter "N/A" for "not applicable." For functions, styles, materials, and areas of significance, enter only the categories and subcategories listed in the instructions. For additional space use continuation sheets (Form 10-900a). Type all entries.

1. Name of Property

historic name Italian Gardeners and Ranchers Association Market Building other names/site number N/A

2. Location

street & number 1305-37 S.E. Union not for publication city, town Portland vicinity state Oregon code OR county Multnomah code 051 zip code 97214

3. Classification

Ownership of Property: private (checked), public-local, public-State, public-Federal. Category of Property: building(s) (checked), district, site, structure, object. Number of Resources within Property: Contributing 1, Noncontributing buildings, sites, structures, objects, Total 1.

Name of related multiple property listing: Historic and Architectural Resources of Eastside Portland. Number of contributing resources previously listed in the National Register: N/A

4. State/Federal Agency Certification

As the designated authority under the National Historic Preservation Act of 1966, as amended, I hereby certify that this nomination (checked) request for determination of eligibility meets the documentation standards for registering properties in the National Register of Historic Places and meets the procedural and professional requirements set forth in 36 CFR Part 60. In my opinion, the property meets (checked) does not meet the National Register criteria. See continuation sheet. Signature of certifying official: Oregon State Historic Preservation Office, Date: January 23, 1989

In my opinion, the property meets (unchecked) does not meet the National Register criteria. See continuation sheet. Signature of commenting or other official: State or Federal agency and bureau: Date:

5. National Park Service Certification

I, hereby, certify that this property is: entered in the National Register (checked), determined eligible for the National Register (unchecked), determined not eligible for the National Register (unchecked), removed from the National Register (unchecked), other (unchecked). Entered in the National Register 3/8/89. Signature of the Keeper, Date of Action

6. Function or Use

Historic Functions (enter categories from instructions)

COMMERCE/TRADE; Department Store

Current Functions (enter categories from instructions)

INDUSTRY/PROCESSING/EXTRACTION;

Manufacturing Facility

7. Description

Architectural Classification

(enter categories from instructions)

OTHER; Commercial

Materials (enter categories from instructions)

foundation Concrete

walls Concrete

Glass

roof Asphalt

other

Describe present and historic physical appearance.

EXTERIOR DESCRIPTION

This building is located in the Central Eastside Industrial District and occupies an entire block. The access ramp to the Hawthorne Bridge is elevated on the south side of the building and obscures part of the top of the building. The front (main) elevation faces Union which is one of the major southbound thoroughfares on the east side of the Willamette River. Union is lined on both sides by a mixture of commercial and industrial buildings.

This structure is square in plan and sits on a concrete foundation with a full basement. A flat roof with full parapet covers the building. The openings in the walls consist of large loading bays on the north and south elevations, elevated loading docks to the rear (west), and numerous multi-paned casement windows with pivoting center sections are found throughout, except on the front elevation. The entire building is constructed of reinforced poured-in-place concrete.

The front (east) elevation is symmetrical with minimal ornamentation. The surface is divided into eight bays by the relief, stepped pilasters which rise up the full height of the structure. The capitals on the pilasters have raised curvilinear and floral embellishments. The windows on the first level are large, single pane display, and the multi-paned casement windows in the upper floor on this elevation have been replaced with aluminum framed windows (c.1985). All other elevations have the original windows. Around the top of the parapet runs a continuous frieze composed of half-circle flower motifs and intersecting diagonals.

United States Department of the Interior
National Park Service

National Register of Historic Places Continuation Sheet

Section number 7 Page 2

INTERIOR DESCRIPTION

The building has now been divided for use by three businesses. Two share the first floor; one occupies the second floor. The original office space is located in the northeast corner of the building, although several of the finishing materials have been changed since construction. A partition wall bisects the first floor. Offices have been created along the front wall on the second floor. Otherwise the entire plan is open. Two ramps - on the north and south walls - lead to the basement. Ramps on the north and west walls provide access to the first floor.

8. Statement of Significance

Certifying official has considered the significance of this property in relation to other properties:

nationally statewide locally

Applicable National Register Criteria A B C D

Criteria Considerations (Exceptions) A B C D E F G

Areas of Significance (enter categories from instructions)

Commerce

Period of Significance

1922-1938

Significant Dates

1922

Cultural Affiliation

N/A

Significant Person

N/A

Architect/Builder

Lucius, W. W.

State significance of property, and justify criteria, criteria considerations, and areas and periods of significance noted above.

The subject building, constructed in 1922, is significant under criterion A for its association with the Italian Gardeners and Ranchers Association, the first major produce wholesaler in the study area. This large association was instrumental in shaping the character of the east side's "produce row", a colorful and vital neighborhood within the larger Central Eastside Industrial District. The architect was Walter W. Lucius. The date of construction is based on City of Portland building permit records.

The Italian Gardeners and Ranchers Association was formed at the turn-of-the-century as a cooperative marketing effort by Italian produce peddlers and truck farmers. Italian immigration to Portland reached an all time high in the years between 1890 and 1910. Many of the newly arrived immigrants settled on the east bank of the river south of Hawthorne Boulevard, and in the Johns Landing area, on the west bank of the river. The area south of Hawthorne was still largely unsettled and provided inexpensive and abundant land on which many of the Italians established small truck farms, maintaining a way of life they had been accustomed to in their native country. By 1900 there were between 150 and 200 street produce peddlers in Portland, a considerable number of whom were Italian.

With the formation of the Italian Gardeners and Ranchers Association, and the subsequent establishment of a large market place shortly thereafter, the farmers and peddlers had a central market location which would help to standardize prices and the quality of the produce. The market was located on the west bank of the river at the foot of Market Street, just south of the

United States Department of the Interior
National Park Service

National Register of Historic Places
Continuation Sheet

Section number 8 Page 2

Hawthorne Bridge. This location afforded easy access to the large Italian communities just south of Hawthorne and in Johns Landing. The market also provided another major benefit by fostering a sense of community among newly arrived immigrants.

The success of this initial market and the poor physical condition of the building led to the purchase of a tract of land on the east side of the river, and the construction of a two-story wood building which covered the entire block between Madison and Main and 3rd and Union. The first major produce wholesaler to locate in the central east side area, the Ranchers and Gardeners Association was followed by a number of other produce and grocery wholesalers, the majority of which concentrated in the area north of Morrison between Second and Union. This area became known as "produce row" and continues to house a large number of produce-related businesses to the present, many of which are operated by Italians.

While catering primarily to produce vendors, the Ranchers and Gardeners building also served as a focal point for community activities. In addition to the produce market, the building included a dairy product section, a specialty Italian import grocer, a pool hall and meeting rooms.

In 1921 the wood building was destroyed by fire and replaced by the subject building within a year. A comparison of Sanborn Insurance maps and city directories indicates that the new building was remarkably similar to the old in layout. Small storefronts faced on to Union Avenue--one of the major north-south streets in the area--and a pool hall, several meeting halls and two Italian restaurants, the Montecatinni and the Ernest Ceccanti, were also present. In 1929 the Association moved into a larger structure located at 10th and Belmont. A number of other produce retailers and wholesalers followed them to this location and created a second "produce row" in the 30s although it disintegrated during World War II.

9. Major Bibliographical References

- . City of Portland Building Bureau microform and card files.
- . City of Portland Bureau of Planning, Portland Historic Resource Inventory, 1983.
- . Multnomah County Tax Assessor records, microform and card files, Portland, 1980.
- . Gould, Charles. "Portland's Italians, 1880-1920". Oregon Quarterly, Vol. 71.
- . Northwest Magazine, September 18, 1977.

Previous documentation on file (NPS):

- preliminary determination of individual listing (36 CFR 67) has been requested
- previously listed in the National Register
- previously determined eligible by the National Register
- designated a National Historic Landmark
- recorded by Historic American Buildings Survey # _____
- recorded by Historic American Engineering Record # _____

See continuation sheet

Primary location of additional data:

- State historic preservation office
- Other State agency
- Federal agency
- Local government
- University
- Other

Specify repository: _____

10. Geographical Data

Acreage of property Less than one acre Portland, Washington-Oregon 1:62500

UTM References

A

1	0	5	2	6	5	0	0	5	0	3	9	8	2	5
Zone		Easting				Northing								

C

--	--	--	--	--	--	--	--	--	--	--	--	--	--	--

B

Zone		Easting				Northing								

D

--	--	--	--	--	--	--	--	--	--	--	--	--	--	--

See continuation sheet

Verbal Boundary Description

East Portland addition, Lot 1-4, Block 90
Exc. E. 20' in Union Ave. Lot 5-8, Block 90

See continuation sheet

Boundary Justification

Taxlot lines

See continuation sheet

11. Form Prepared By

name/title K. Zisman, J. Koler, J. Morrison, B. Grimala, A. Yost
 organization Hawthorne Blvd. Business Association date August 15, 1988
 street & number 615 S.E. Alder telephone (503) 234-4801
 city or town Portland state Oregon zip code 97214

S.E. SECOND

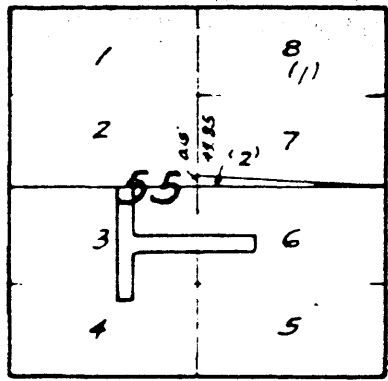

S.E. THIRD

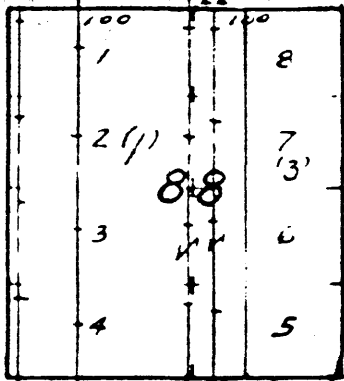

S.E. UNION

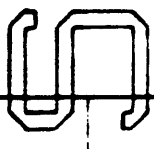
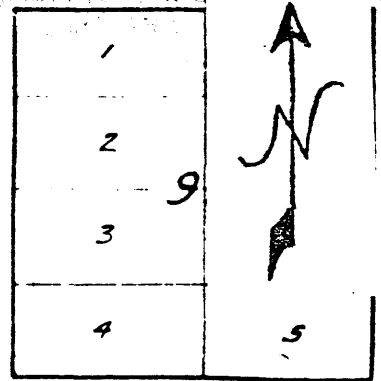

S.E. Salmon

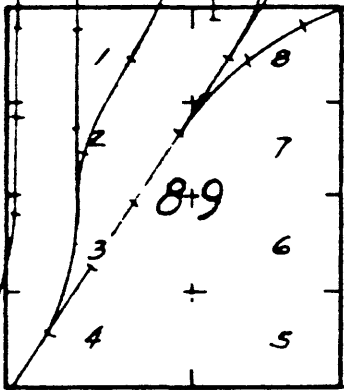
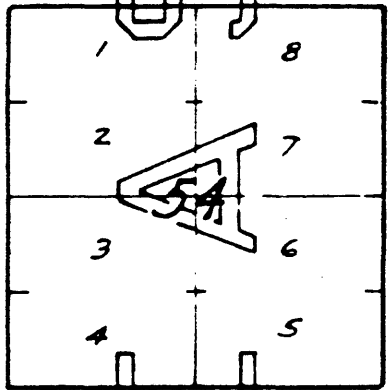

S.E. Main

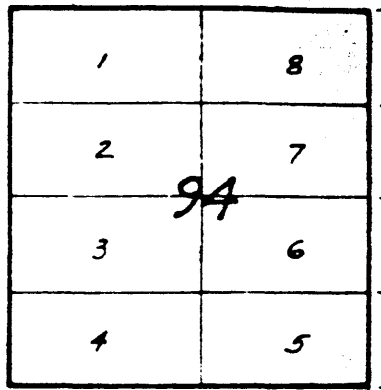

ST.

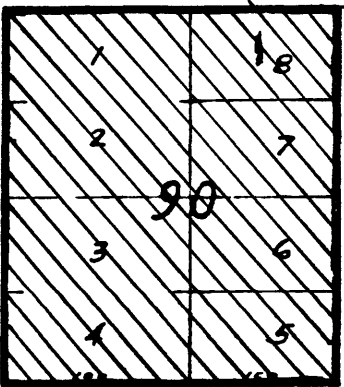
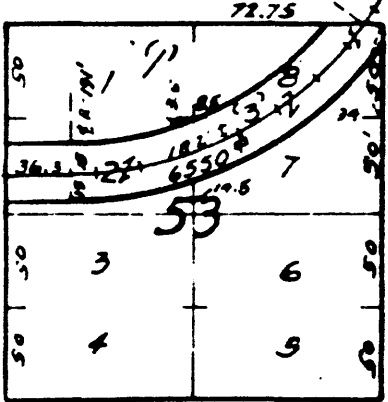

REF, 1962b, 5-14-30

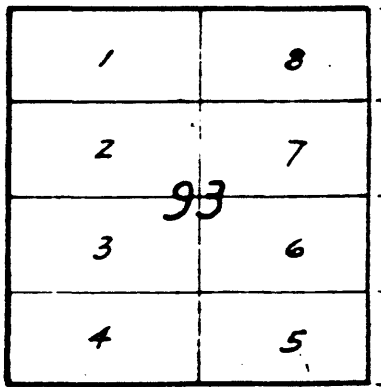

S.E. Madison

N. 88° 12' 12" W.

(2) of Blks 92/93 642

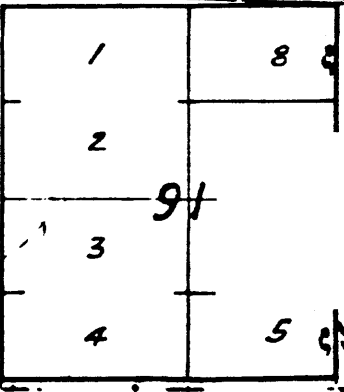
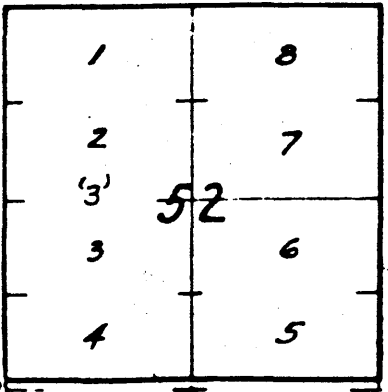

1305 -37 S.E. Union
Portland, OR 97214

HAWTHORNE

N. 88° 12' 12" W.

ORD 7616, 2-25-92
70' WIDE FROM RIVER
E. TO E. 11TH ST.

N. 63° 19'



- 1) ITALIAN GARIBOLDI'S RANCHMAN'S MARKET BLDG. 1305-37 SE UNION
- 2) PORTLAND, OREGON Multnomah County
- 3) PATRICK SMITH
- 4) AUGUST 1988
- 5) ROLL S 42 # 15
- 6) EAST. ELEVATION
- 7) # 1 OF 2

Portland Eastside mps



ITALIAN CANNONBALLS AND FRANCISANS

1. MARKET BUILDING / 1305-37 S.E. Union
2. Portland, Oregon, Multnomah County
3. Jane Morrison
4. August 1988
5. Roll J-5 # 6
6. Interior of ground level warehouse area.
7. # 2 OF 2

Portland Eastside MPS